

CMP40

HYDRAULIC COMPACTOR

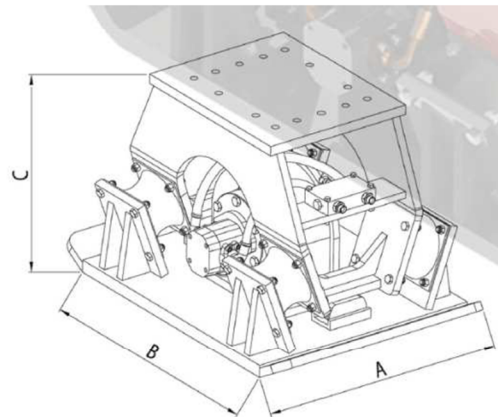

PC Hydraulic Compactors are mounted on Mini Excavators, Backhoe-Loaders and similar Main Machines with hydraulic power unit. Hydraulic Compactor does compacting by high frequency impact power. This vibration force is used for compacting of soil, granular material, piles, driving of post and steel sheeting timber. The optional rotation function turns the compactor 360 degree.

5



TECHNICAL INFORMATION		
Operating Weight	Kg Lb	505 1100
Compacting Power	Kg Lb	3500 7716
Frequency	N/m	2000
Operating Pressure	Bar PSI	150 2200
Oil Flow	LPM GPM	75 20
Height-C	mm in	550 20
Bottom Plate Axb	mm in	690x870 25x34
Suitable Excavator	Ton lb	4-10 8800-22000